



**KANOMAX**

# Piezobalance Dust Monitor

## MODEL 3521

### Operation Manual

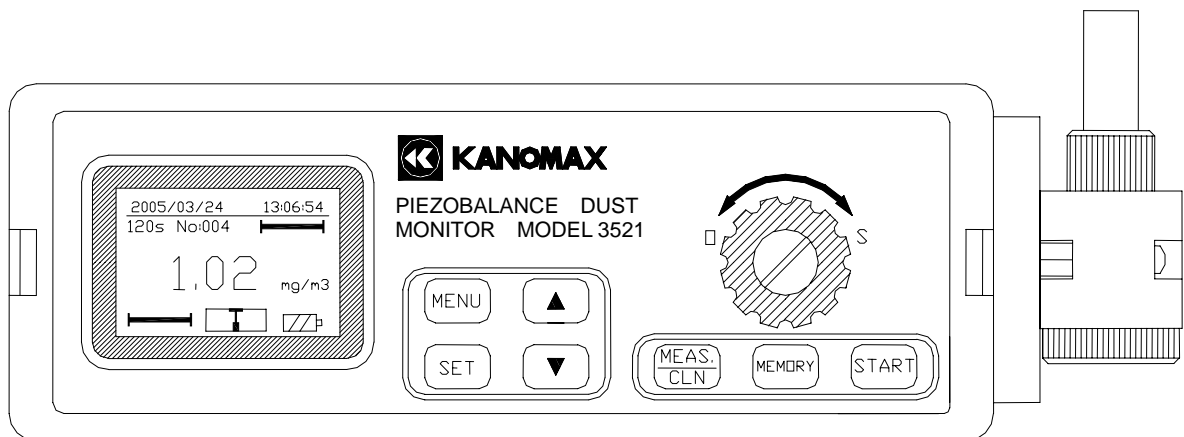

Read this manual carefully and understand the warnings  
before operating the instrument.  
Keep this manual handy for future reference.



# Important Safety Information

Types and definitions of warning signs used in this operation manual are shown below.



**Danger:** To prevent serious injury or death.

Items under this heading show measures to prevent serious injury or death, which may result if the instructions in this manual are not observed and the instrument is operated inappropriately.



**Caution:** To prevent damage to the product.

Items under this heading show measures to prevent damage to the product and conditions that affect our product warranty.

[Description of Symbols]



△ This symbol indicates a condition (including danger) that requires caution. The subject of each caution is illustrated inside the triangle (e.g., high temperature caution symbol shown on the left).



⊘ This symbol indicates prohibition. Do not take a prohibited action shown inside or near this symbol (e.g., disassembly prohibition symbol shown on the left).



● This symbol indicates a mandatory action. A specific action is given near the symbol.

|   |                                    |
|---|------------------------------------|
| <b>Danger</b>   |                                    |
| <p><b>* Never expose the instrument to flammable gas.</b></p>   | <br>Do not use near flammable gas. |
| <p><b>* Never disassemble or heat the battery pack, or discard the battery pack in fire.</b></p> <p>..... The battery pack may explode.</p>   | Explosive          Handle Properly |
| <p><b>* Never perform the cleaning procedure with instrument set to high voltage (if high-voltage is active, the pointer will be located at the center of the indicator.)</b></p> <p>..... Performing cleaning while high-voltage is active may cause electrical shock.</p> | Prohibition                        |

Caution



**\* Do not drop or hit the instrument.**

..... Dropping or hitting the instrument may cause damage or malfunction.



Prohibition

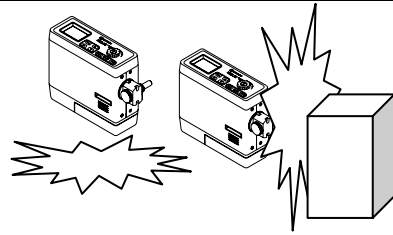

**\* Never disassemble, modify or repair the instrument.**

..... Failure to observe the above may cause short circuit and malfunction.



Do not modify / disassemble

**\* Do not clog the impactor inlet with a dirty hand.**

..... Failure to observe the above may cause pump failure.



Prohibition

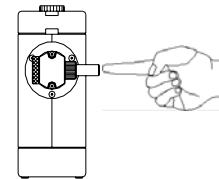

**\* Do not perform a measurement in an environment with extreme temperature/humidity change.**

..... Use in an environment with extreme temperature/humidity change may cause error in measurement value.

The allowable rate of change during a 2 minute measurement is:

Temperature:  $\pm 1^{\circ}\text{C}$  ( $0^{\circ}\text{C}$  to  $40^{\circ}\text{C}$ ), Humidity:  $\pm 1\%\text{RH}$  ( $30\%\text{RH}$  to  $80\%\text{RH}$ ).



Handle Properly

**\* Do not wipe the instrument with a volatile solvent.**

..... The body may deform or deteriorate. Use soft dry cloth to remove stains. If stains persist, soak the cloth in a neutral detergent and wipe the instrument with a soft cloth.

Do not use volatile solvents such as thinner and benzene.



Prohibition

**\* Make sure there is no turbulent flow near the sampling inlet.**

..... Turbulent flow may cause measurement error.



Handle Properly

**\* Do not attempt cleaning in an environment where temperature is below  $0^{\circ}\text{C}$ .**

..... Cleaning sponge may freeze and cause damage to the sensor.



Prohibition

# Table of Contents

|  |           |
|--|-----------|
| <b>1. Part Names and Functions .....</b>                           | <b>1</b>  |
| 1.1 Part Names.....  | 1         |
| 1.2 LCD Screen .....   | 2         |
| 1.3 Operation Keys .....   | 2         |
| <b>2. Battery Indicator.....</b>                                   | <b>3</b>  |
| <b>3. Battery Charge .....</b>                                     | <b>4</b>  |
| 3.1 AC/DC Adapter.....   | 4         |
| 3.2 Battery Charging Display .....                                 | 4         |
| <b>4. Parts Installation and Measurement Preparation .....</b>     | <b>5</b>  |
| 4.1 Removal and Installation of Rechargeable Battery Pack.....     | 5         |
| 4.2 Removal and Installation of Cleaning Device .....              | 6         |
| 4.3 Confirming the Sensor Condition .....                          | 7         |
| 4.4 Cleaning the Sponge.....                                       | 8         |
| 4.5 Cleaning the Sensor .....                                      | 9         |
| 4.6 Adjusting the Impactor Position .....                          | 10        |
| 4.7 Sampling Time.....   | 10        |
| <b>5. Measurement Method.....</b>                                  | <b>11</b> |
| 5.1 High Voltage Supply.....                                       | 11        |
| 5.2 Measurement Start .....  | 12        |
| 5.3 Measurement End .....  | 13        |
| <b>6. Setting the Menu .....</b>                                   | <b>14</b> |
| 6.1 Main Menu .....  | 14        |
| 6.2 Sampling Time Menu .....                                       | 14        |
| 6.3 Data Output Menu .....   | 15        |
| 6.4 Time Adjustment Menu .....                                     | 15        |
| 6.5 Communication Menu .....                                       | 16        |
| 6.6 Data Clear Menu.....   | 17        |
| <b>7. Printing .....</b>   | <b>18</b> |
| 7.1 Connecting the Printer .....                                   | 18        |
| 7.2 Print Output Menu .....  | 18        |
| <b>8. Regular Maintenance and Impactor Nozzle Replacement.....</b> | <b>19</b> |
| 8.1 Impactor Cleaning .....  | 19        |
| 8.2 Removing and Cleaning the Needle .....                         | 20        |
| 8.3 Installing the Needle.....                                     | 20        |
| 8.3 Installing the Needle.....                                     | 21        |
| 8.4 Impactor Nozzle .....  | 21        |
| <b>9. Main Specifications.....</b>                                 | <b>22</b> |

|   |           |
|---|-----------|
| <b>10. Troubleshooting.....</b>                   | <b>23</b> |
| <b>11. Warranty and After-sales Service .....</b> | <b>24</b> |
| <b>12. Contact Information .....</b>              | <b>25</b> |

# 1. Part Names and Functions

## 1.1 Part Names

(unit: mm)

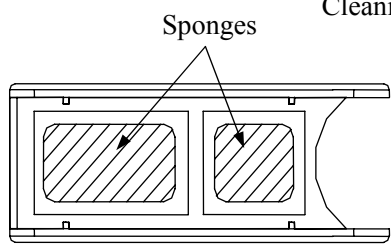
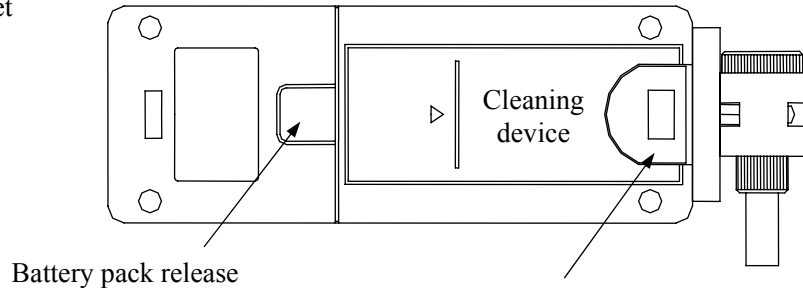
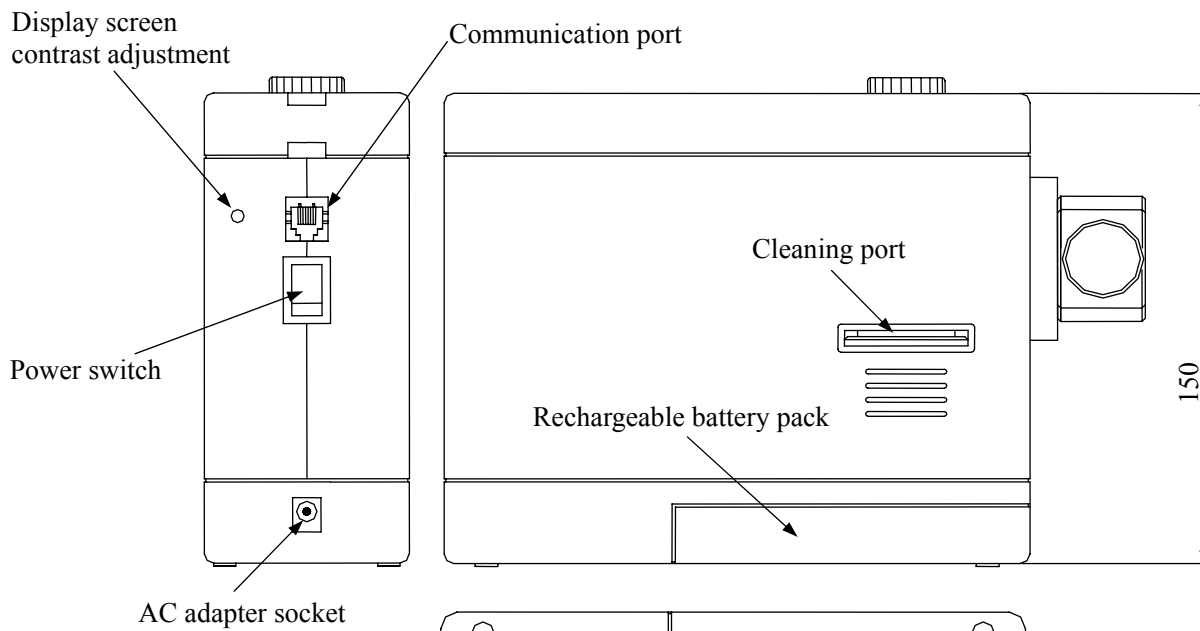
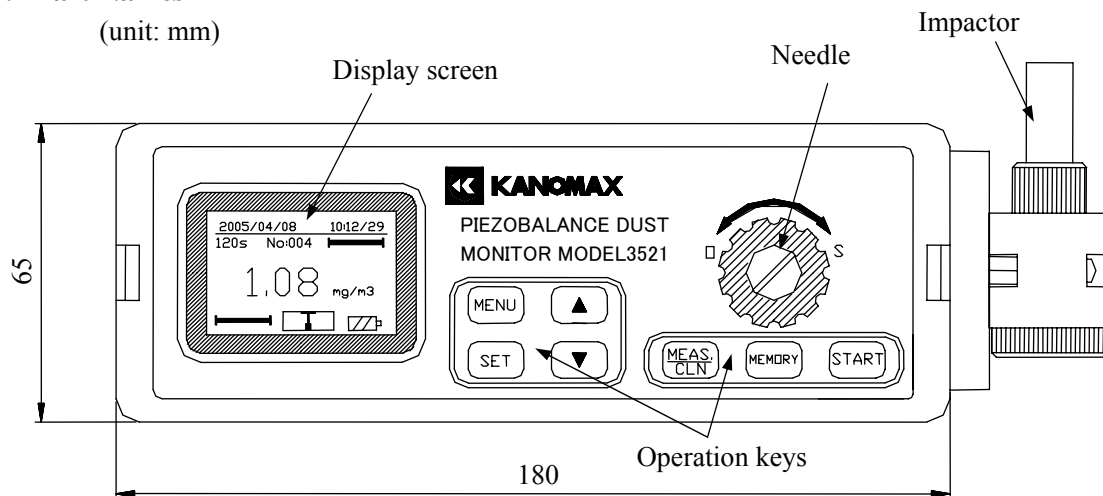

## 1.2 LCD Screen

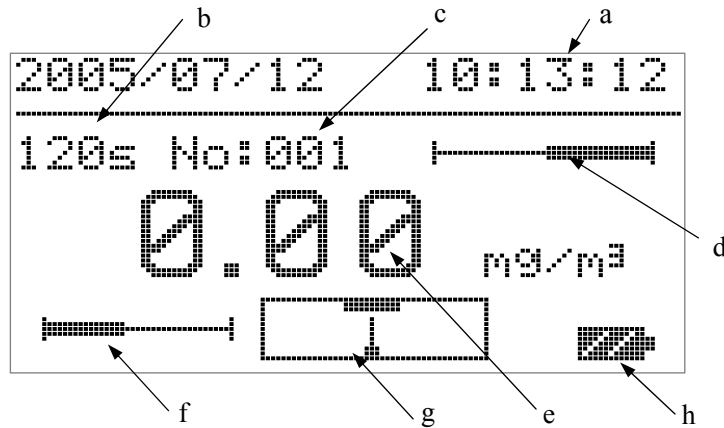

- a. Date & Time:**  
Indicates current date & time.
- b. Sampling Time:**  
Sampling time can be quick set to either 24s or 120s or custom set from 1-60min.
- c. Data Record:**  
Indicates current number of data records (Max.500). When measurement is complete, "STORE" will flash here. To save data, press the [MEMORY] key.
- d. Measurable Range:**  
Remaining measurable range is indicated by a bar indicator, which moves towards the right as the sensor absorbs dust and the measurable range decreases. When the sampled dust exceeds approx. 10 $\mu$ g (>Fundamental Frequency + 2000Hz), "CLEANING" will flash here. The cleaning procedure must be performed when the remaining measurable range is too small or "CLEANING" flashes.
- e. Concentration Reading:**  
The concentration reading flashes during a measuring.
- f. Operating Status:**  
"WAIT" flashes during cleaning and power-up.  
"READY" flashes when high voltage is supplied and the instrument is ready for measurement.  
Remaining sampling time is displayed during a measurement.
- g. High Voltage Indicator:**  
High voltage status indicates when high voltage is supplied. When the pointer moves to the center of the frame (under the black block), the operating status changes to "READY", and the instrument is ready for measurement.
- h. Battery Indicator:**  
Indicates remaining battery power.

## 1.3 Operation Keys

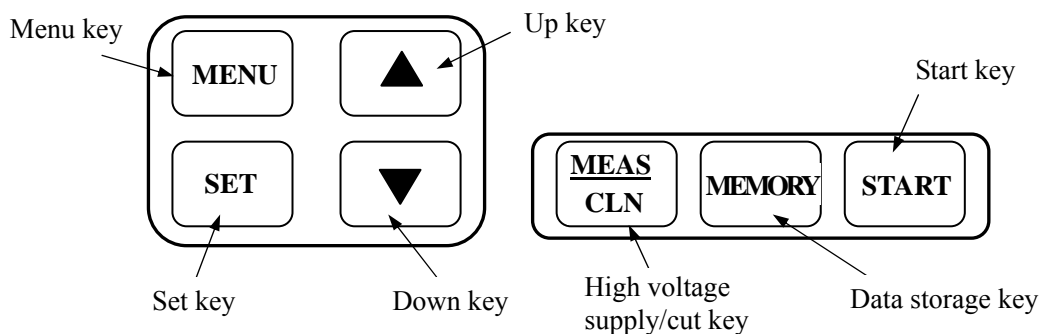

## 2. Battery Indicator

---

Remaining battery life displays while the instrument is powered on.  
The battery indicator changes as shown below.

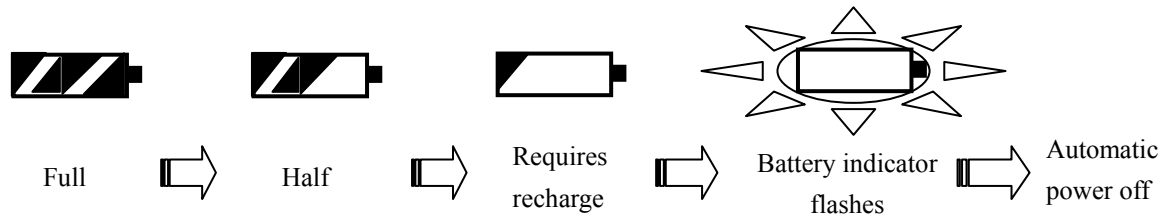

- The battery indicator flashes when the battery voltage drops below 9.3V. The battery must be charged immediately to continue a measurement.
- If the battery is left uncharged, the instrument will be powered off automatically.



## 3. Battery Charge

---

### 3.1 AC/DC Adapter

For prolonged measurements, the instrument should be powered using the supplied AC/DC adapter where AC100-240V power is available. Insert the adapter jack into the adapter socket of the instrument first, and then to a power outlet.

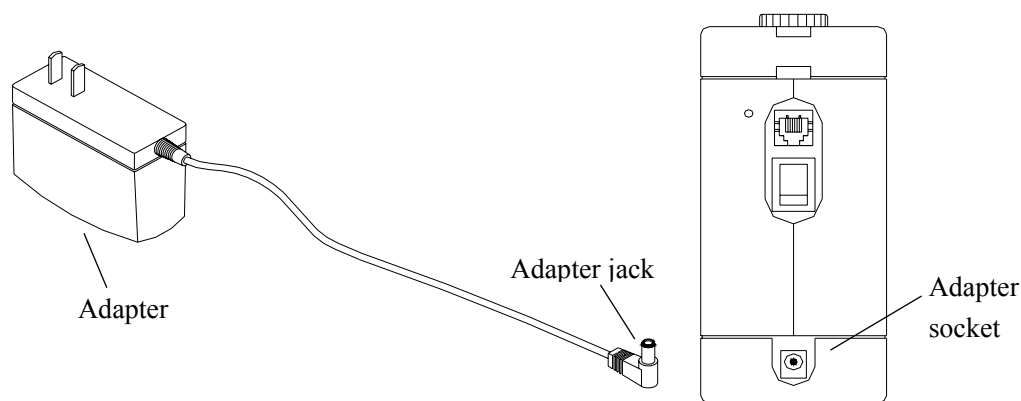

When AC power is supplied, the battery charging status bar will display on the screen.

While the battery is being charged, the bar indicator will be moving.

When the battery is fully charged, the bar indicator will stop moving.

### 3.2 Battery Charging Display

The battery can be recharged while the instrument is turned OFF or ON. The bar indicator shown on the right displays the charging status while the battery is being charged.

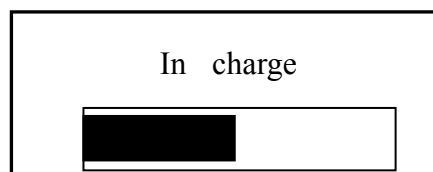

When the battery is fully charged as shown on the right, unplug the adapter, and charging is complete.

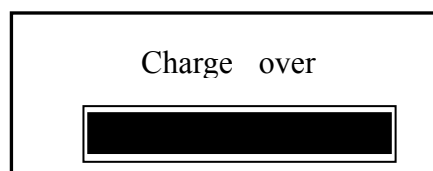

#### Caution:

- 1) The input of the AC/DC adapter is AC 100-240v and the output is DC 12.5v. Do not use an adapter other than the one supplied with the instrument. Use of unspecified adapters may cause charging failure or damage to the instrument.
- 2) The estimated continuous operating time using the rechargeable Ni-MH battery is approx. 4.5 hours. Charging time is approx. 5-8 hours.
- 3) If the instrument is not to be used for an extended period, the battery should be charged once a month in order to extend the service life of the battery.
- 4) Before starting a measurement, if the adapter plug is inserted into the socket while the instrument is turned off, the charging status will be displayed on the screen. A measurement can be performed under this condition by turning on the power. To perform a measurement without using the adapter, it is recommended that the battery be fully charged before use.
- 5) Turn off the instrument after a measurement is complete. If the adapter is left inserted into the socket, the charging status will be displayed on the screen. If there is sufficient battery remaining, the adapter must be unplugged as charging is not necessary.

## 4. Parts Installation and Measurement Preparation

---

### 4.1 Removal and Installation of Rechargeable Battery Pack

- 1) Press the rechargeable battery pack release, and slide the battery pack along the guiding groove away from the release as shown below.

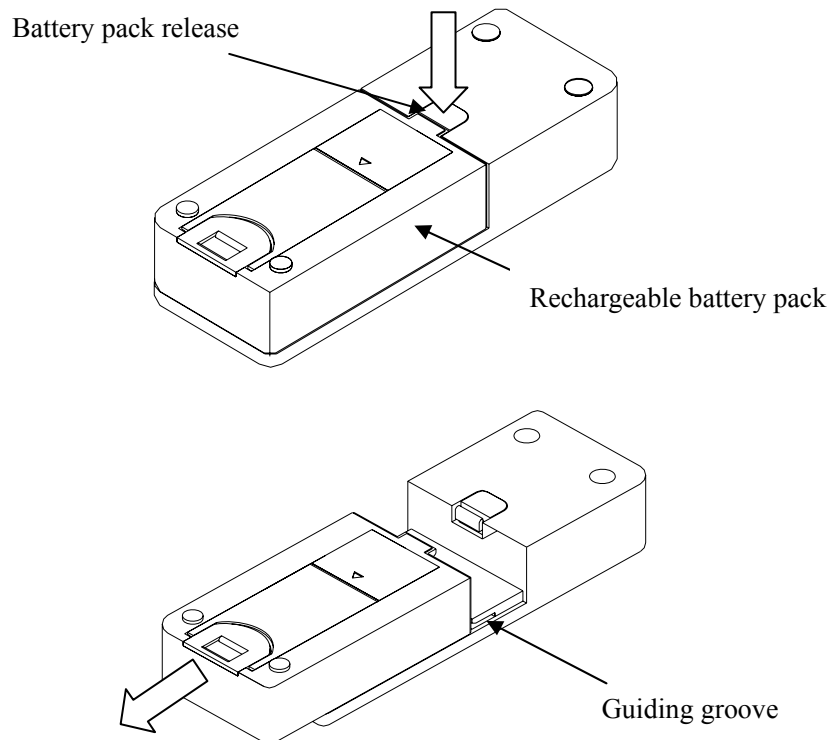

- 2) Align the tabs on the rechargeable battery pack with the slots in the guiding groove and lift the battery pack free from the instrument.

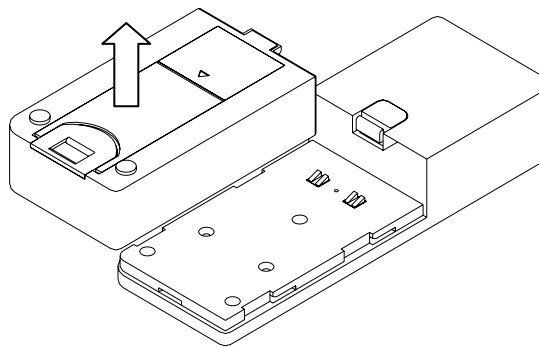

- 3) To reinstall the battery pack, reverse the above procedure.

## 4.2 Removal and Installation of Cleaning Device

- 1) Hold the cleaning device, and slide the lock away from the cleaning device as shown below.

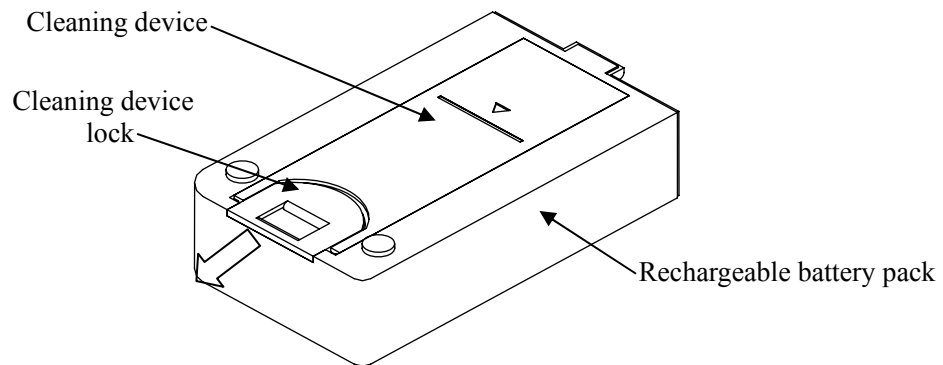

- 2) After the lock is released, remove the cleaning device by holding the front end.

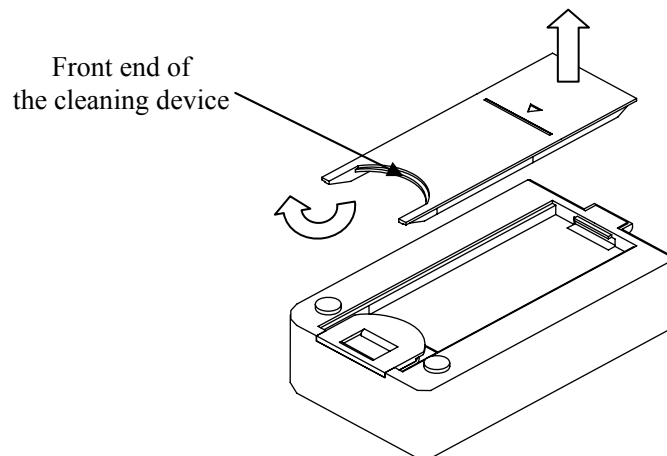

- 3) To install the cleaning device, place the rear end of the cleaning device onto the battery pack first, and then push the front end of the cleaning device into the locker. After the cleaning device is installed, push the lock to its original position.

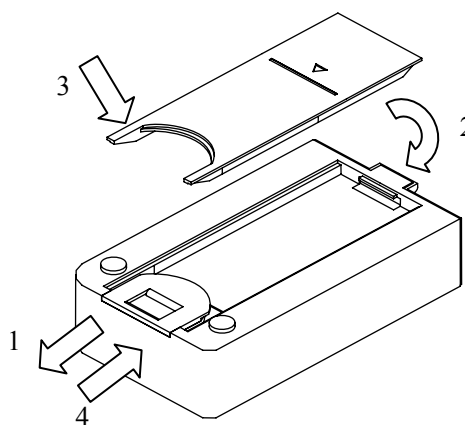

### 4.3 Confirming the Sensor Condition

When the instrument is powered on, the screen below will display with a flashing “WAIT” message in the operating status field. After approx. 10 seconds the sensor will stabilize and the “WAIT” message will stop flashing.

The measurable range of the sensor can be confirmed by the bar indicator and the frequency displayed on the screen.

#### 1) Confirming the Measurable Range using the Bar Indicator:

The bar indicator will be at full length immediately after cleaning. The bar will move to the right, decreasing in length as dust accumulates on the sensor. When the remaining length of the bar indicator is short, or when “CLEANING” is flashing, the sensor should be cleaned immediately. (Refer to section 4.4 and 4.5 for cleaning.)

#### 2) Confirming the Measurable Range using the Frequency display:

The frequency can be displayed by pressing the   key, and hidden by pressing the   key again.

The frequency will increase as dust accumulates on the sensor. When the frequency exceeds the Fundamental Frequency + 2000Hz, “CLEANING” will flash. Cleaning should be done immediately.

\* The frequency increases as the length of the measurable range bar indicator decreases.

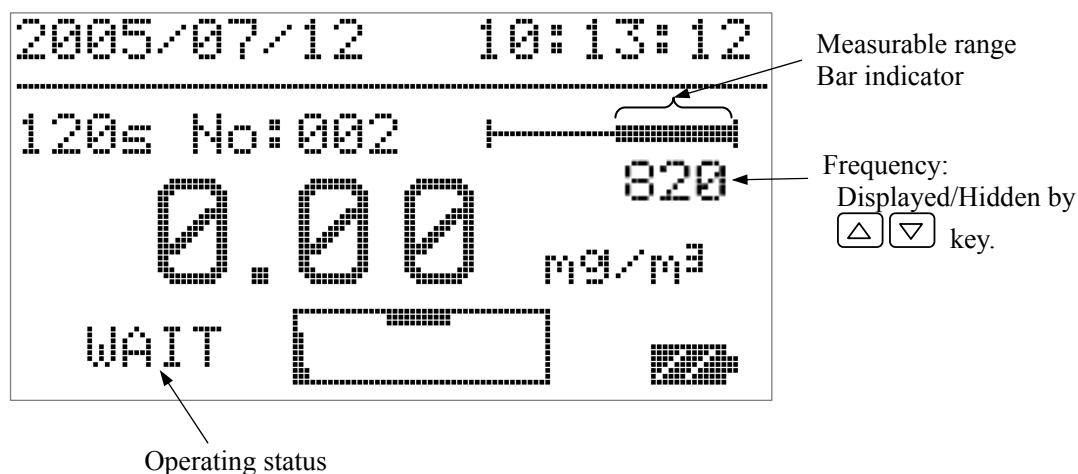

#### Caution:

Confirm that the bar indicator has sufficient length before starting a measurement. Never leave dust accumulated on the sensor as it may prevent the bar indicator from recovering even after providing cleaning. It can also affect the frequency display, which will affect the measurement accuracy.

## 4.4 Cleaning the Sponge

### Preparation Before Cleaning

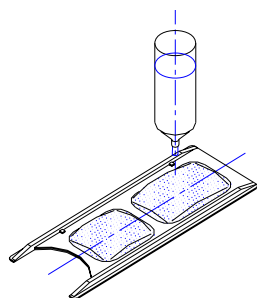
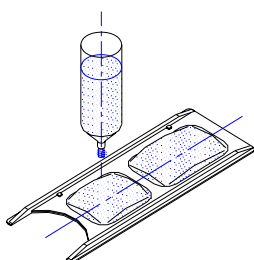
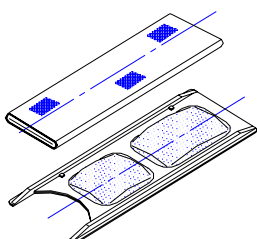
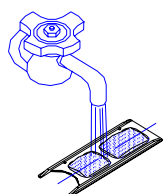
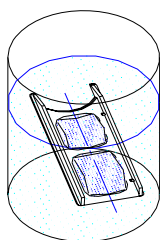

- 1) The sponge on the cleaning device must be moistened before use. If the sponge is unclean or stained, put the cleaning device into a vessel filled with clean water with a few drops of neutral detergent, and leave it for a few minutes (this is not necessary for a new product).
- 2) When the stain is removed, wash the sponge with running water and completely remove all detergent.
- 3) Use a folded tissue or paper towel on the cleaning device to remove all excess water from the sponge. This process should be repeated several times to ensure removal of all moisture.
- 4) Put 1-2 drops of detergent (blue) on the SMALLER sponge.
- 5) Put 2-3 drops of purified water on the LARGER sponge.

### Caution:

- 1) Note that the two sponges differ in size. The proper amount of detergent must be dropped on the smaller sponge.
- 2) If the sponge is dirty or stained with oil that cannot be removed by washing in clean water, put the cleaning device into a vessel filled with clean water with 3-4 drops of neutral detergent. After the stain is removed, wash the sponge with clean water.
- 3) If the stain cannot be removed from the sponge or if the sponge is damaged, the sponge must be discarded. Please contact your local distributor or our service center to purchase a new sponge.
- 4) Any water remaining on the cleaning device other than the sponge itself must be removed completely using a folded tissue or paper towel. If the cleaning device is inserted in the instrument with water drops, they may attach to the sensor or needle, causing recovery failure of the measurable range or failure when applying high voltage.
- 5) Use of a sponge with excessive moisture may require a very long time to dry. In addition, the instrument reading may become unstable, and the "WAIT" message may not display.
- 6) Do not use a detergent other than the one specified. Use of other detergents may result in an oily film to remain or accumulation of sediment, which will affect the measurement.

## 4.5 Cleaning the Sensor

First, confirm that the high voltage is turned OFF. Then align the front end of the cleaning device with the cleaning port, and slowly insert the cleaning device with the sponge side facing down. The cleaning device must be inserted up to the scale line indicated on the back side of the cleaning device. When the scale line reaches the port, stop inserting and wait for approx. 20 seconds. Then, insert the cleaning device further, and pull it out from the other side. The sensor will then be dried, and a flashing “WAIT” message will be displayed on the screen. Approximately 3 minutes is required for drying. When the sensor is dried, the “WAIT” message will stop flashing. The bar indicator of the measurable range must return to the initial position. If the indicator is not returned to its initial position, the above cleaning process must be repeated again as there may be dust remaining on the sensor.

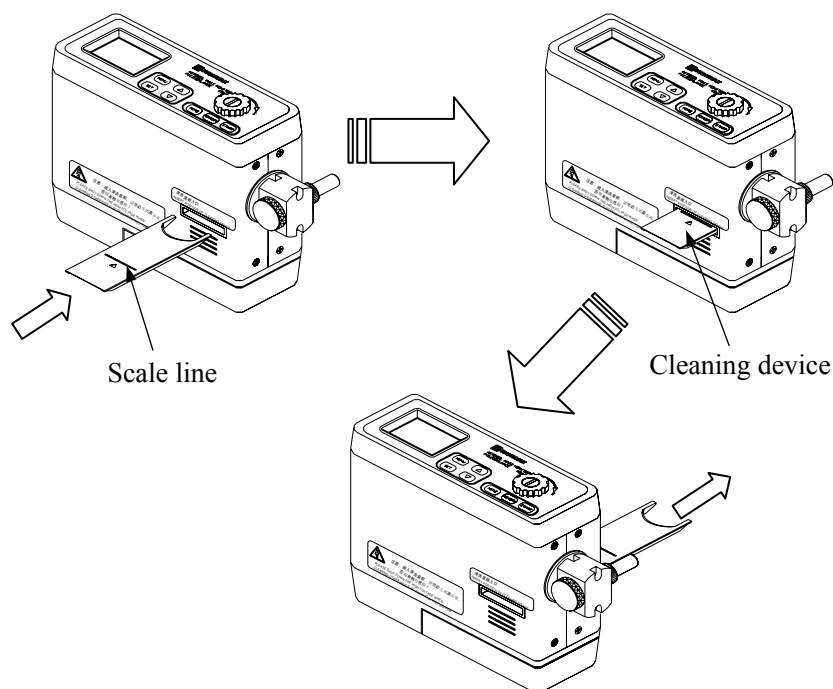

### Caution:

- 1) Ensure that the high voltage is turned OFF before cleaning the sensor.  
Residual high voltage is not fully discharged right after power off. Before starting cleaning, confirm that the pointer of the high voltage indicator is returned to the left end.
- 2) While the sensor is cleaned, the flashing “WAIT” message will be displayed. During this period, high voltage cannot be supplied even if the [MEAS] key is pressed. This is not a malfunction. When the sensor is dried, the “WAIT” message will stop flashing. Excess moisture on the cleaning device could lead to a prolonged drying time. If that is the case, the moisture on the sponge should be absorbed using a folded tissue or paper towel and cleaning must be performed again.
- 3) Do not force the cleaning device in if the sponge is torn or protruding from the cleaning device. Forcing in the cleaning device could apply excessive pressure to the sensor causing damage.
- 4) Use of an unclean sponge could prevent the measurable range indicator from returning to its initial position. Ensure that the sponge is completely cleaned before performing a sensor cleaning.
- 5) Do not perform a sensor cleaning if the ambient temperature is below freezing.

## 4.6 Adjusting the Impactor Position

Impactor may be set in three positions. A stopper is provided for fixing the impactor in three angles: 0°, 45° and 90°. Fix the impactor at the desired angle.

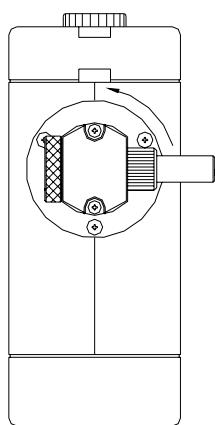

Rotation angle: 0°

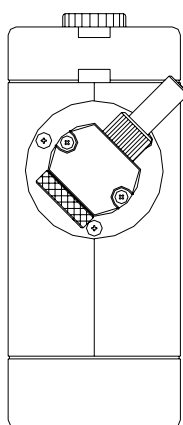

Rotation angle: 45°

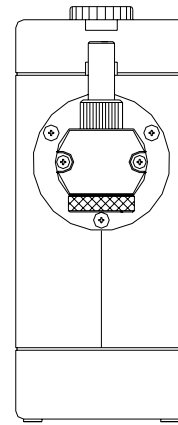

Rotation angle: 90°

## 4.7 Sampling Time

For how to set the sampling time, see Section 6. Setting the Menu”.

The initial setting of the sampling mode is 120s.

Change the setting according to the dust concentration of the environment to be measured.

When performing measurements in a high concentration environment, such as a work environment, select 24s. For indoor measurement in a low concentration environment, select 120s.

For measurements in a high concentration environment, the cleaning frequency can be reduced by setting a short sampling time. For measurements in a low concentration environment, the measurement accuracy can be increased by extending the sampling time.

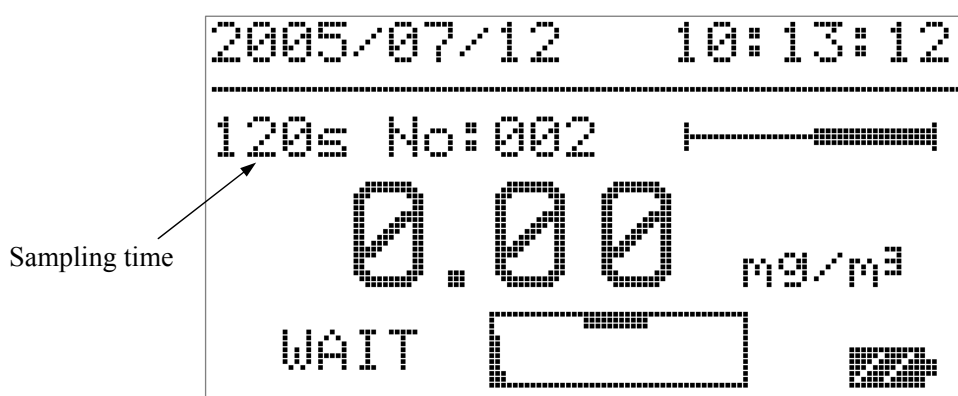

## 5. Measurement Method

---

### 5.1 High Voltage Supply

On turning on the instrument, the flashing “WAIT” message will be displayed. After a brief delay, the “WAIT” message will stop flashing, and high voltage can be supplied. Press the [MEAS/CLN] key to supply high voltage. The pointer at the left end of the high-voltage indicator frame will move toward the right. The pointer will stop at the center of the frame under the black block. When the sensor becomes stable, the operating status will change from “WAIT” to “READY” and the instrument will be ready for measurement.

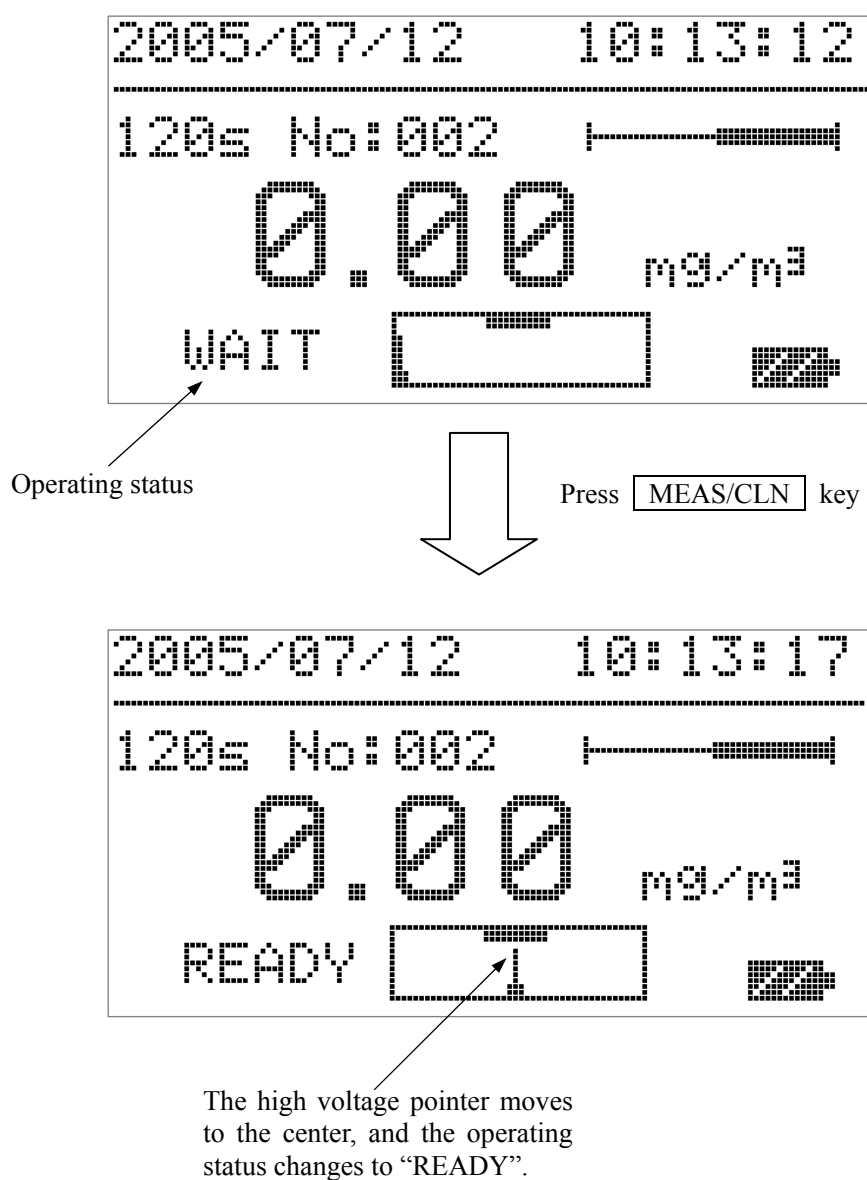



## 5.2 Measurement Start

To start a measurement, press the [START] key after the operating status has changed to “READY”. Then the “READY” message will change to an elapsed time indicator. The bar indicator will extend as the time elapses. The concentration reading will be blinking during a measurement. The measurement will stop automatically when set time has elapsed. The reading also stops flashing and the final concentration value is displayed.

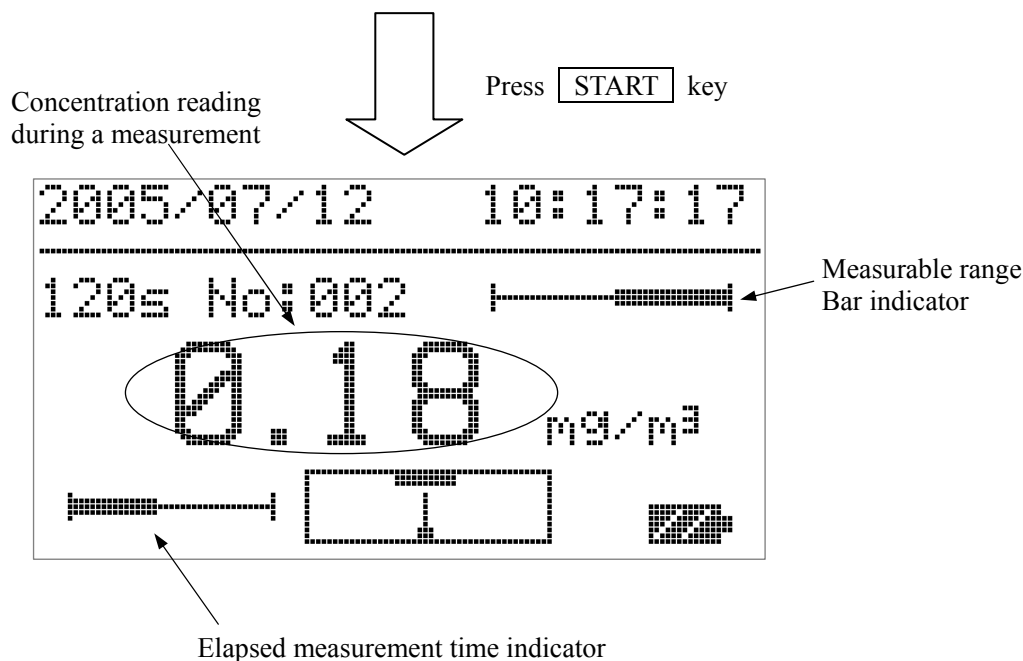

### Caution:

- 1) When [START] key is pressed during a measurement, the measurement will stop and the concentration reading will change to “-.-.-”.
- 2) When [MEAS/CLN] key is pressed during a measurement, the measurement will stop. The high voltage supply will stop and the concentration reading will change to “-.-.-”. This procedure allows emergency stop during a measurement or canceling a measurement.
- 3) If the dust sampled during a measurement exceeds the measurable range, the measurable range indicator will change to a flashing “CLEANING” message. If a sampling time of 24s or 120s was selected, the measurement will continue. After the measurement is complete, high-voltage supply will stop automatically to prevent further measurement. Perform a sensor cleaning to restore the instrument to a measurable condition. When an arbitrary sampling time was set using TSET, the measurement will stop immediately if the measurable range is exceeded. The data sampled up to that point will not be saved in this case.
- 4) After the completion of each measurement, “STORE” will flash. This is asking whether you want to save the data or not. You can ignore this message if you do not want to save the data.
- 5) The reading of 0.00mg/m<sup>3</sup> will be flashing for 5 seconds after starting a measurement. This is because the reading is updated every 5 seconds.

### 5.3 Measurement End

When the measurement is complete, the concentration reading will stop flashing. The displayed value is the measurement result for the specified sampling time. The operating status display will change from the elapsed time indicator to the “READY” message, and the number of data records will change to a flashing “STORE” message. If you want to save the measurement result, press the [MEMORY] key. Ignore the message if you do not want to save the result.

To start another measurement, press the [START] key.

To end the measurement, press the [MEAS/CLN] key to stop the high voltage supply. Then, turn off the power.

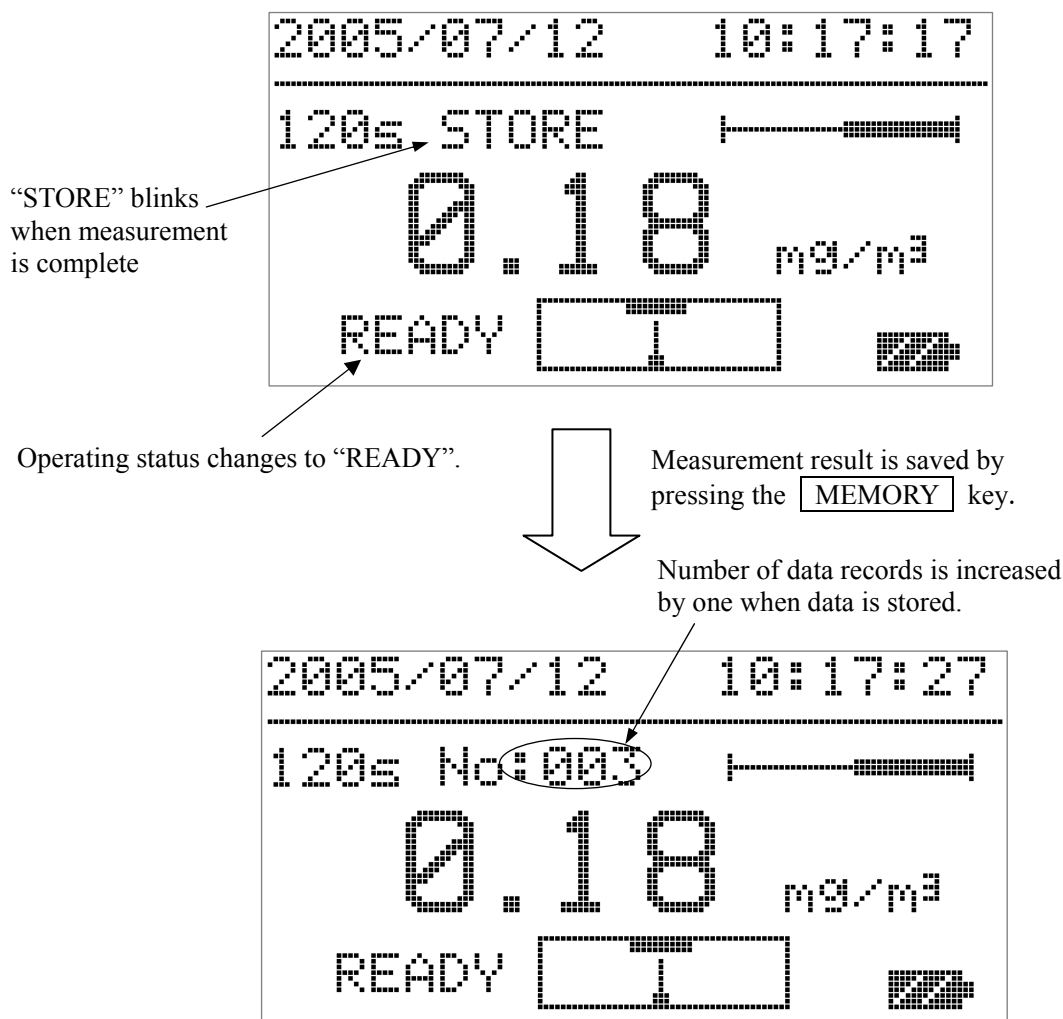

#### Caution:

When a measurement is complete, it is recommended that the sensor is cleaned before powering down the instrument for the convenience of future measurements.

The accumulated dust left on the sensor will become hard to clean, and will lead to a gradual reduction of the measurable range.

## 6. Setting the Menu

### 6.1 Main Menu

The following menu will be displayed by pressing the [MENU] key when high voltage is not supplied to the instrument. Use the  $\triangle$   $\nabla$  keys to select each item.

To enter the sub-menu of each item, press the [SET] key.

To switch to the measurement screen, select "1. NORMAL" and press the [SET] key.

```
MENU | 0. NORMAL
      | 1. SAMPLING TIME
      | 2. DATA OUTPUT
      | 3. PRINT OUTPUT
      | 4. DATA CLEAR
      | 5. TIME ADJUST
      | 6. COMMUNICATION
```

### 6.2 Sampling Time Menu

#### To set the measurement sampling time

```
SAMPLING TIME
-----
0. 120s
2. SAVE INFO
```

Select "1" and  
press  $\square$  key.

```
SAMPLING TIME
-----
1. 20s
2. SAVE INFO
```

Select "1" and  
press  $\square$  key.

```
SAMPLING TIME
-----
1. TSET
   CHANGEOVER 01m
2. SAVE INFO
```

Move the cursor to item "2. SAMPLING TIME" of the main menu by using the  $\triangle$   $\nabla$  key, and press the [SET] key. The screen on the left will be displayed.

**Caution:** If [MENU] key is pressed before pressing the "2. SAVE INFO", the set time will NOT be saved.

Change the setting time by using the  $\triangle$   $\nabla$  key.

The setting changes as below:

```
120s → 24s → TSET
      ↑
```

When [SET] key is pressed on 120s or 24s, the cursor will return to the "1."

When [SET] key is pressed on "TSET", the following screen will be displayed.

Set the time by using the  $\triangle$   $\nabla$  key.

The settable time range is 1-60min.

When [SET] is pressed, the cursor will return on "1."



To enter the set time, move the cursor to the "2. SAVE INFO" by using the  $\triangle$   $\nabla$  key, and press the [SET] key.

#### Caution:

After completing the time setup, confirm the setting on the measurement screen. When you have made the TSET setting, the display will simply show "TSET" (the specified time will not be displayed.) The elapsed time indicator will be in full scale.

## 6.3 Data Output Menu



### To select and view stored data

Move the cursor to item “3. DATA OUTPUT” of the main menu by using the   key and press the [SET] key. The screen as below will be displayed.

When there is no data stored, the message “There is no record. Please set MENU key” will be displayed.

```

DATA OUTPUT      No: 00
-----
MASS CONCENTRATION
                   0.18 mg/m³
DATE              2005/07/12
TIME              10:17:27
SAMPLING TIME    0120s
STATUS           0
    
```

The data storage number can be selected by using the   key. On releasing the key, the contents (concentration, date/time, sampling time and sampling status) will be displayed.



No: Data storage number  
 MASS CONCENTRATION: Measured concentration value  
 DATE / TIME: Date/Time the measurement was performed  
 SAMPLING TIME: Sampling mode: 24s, 120s or TSET (1-60min).  
 STATUS: Sampling status. 0 or 1  
 0: Normal measurement condition  
 1: Indicated when the measurable range is exceeded during a measurement in sampling mode 24s or 120s.

## 6.4 Time Adjustment Menu

### To set the data and time

```

TIME ADJUST
-----
1. DATE      2005/07/12
2. TIME      10:17:27
3. SAVE INFO
    
```



Move the cursor to item “6. TIME ADJUST” of the main menu by using the   key and press the [SET] key. The screen on the left will be displayed.

When “3. SAVE INFO” is pressed, the set date/time will be saved, and the screen will return to the menu. On pressing the [SET] key on “1” or “2”, the following screen will be displayed.

Select “1. DATE”  
and press  key

```



TIME ADJUST
-----
1. DATE      2005/07/12
2. TIME      10:17:27
3. SAVE INFO
    
```

Set the year, month and day by using the   key. Press the [SET] key to proceed to the next item. When day is set, the cursor will return to the “1. DATE”. Move to item “2. TIME” and press the [SET] key. The next screen will be displayed.

Select “2. TIME”  
and press  key



```

TIME ADJUST
-----
1. DATE      2005/07/12
2. TIME      10:17:27
3. SAVE INFO
    
```



Set the hour, minute and second by using the   key, and press the [SET] key. Set the time for approx. 30-60sec in the future, then press “3. SAVE INFO” when the set time comes. The set time will be entered, and the screen will return to the menu.

## 6.5 Communication Menu

### To set the communication baud rate

Move the cursor to item “7.COMMUNICATION” of the main menu by using the   key, and press the [SET] key. The screen as shown below will be displayed.

```
COMMUNICATION
-----
1. BAUDRATE
    19200
2. SAVE INFO
```

Select “1” by using the   key.

(The factory default setting is 9600.)

Select “1.BAUDRATE” and press  key.

```
COMMUNICATION
-----
1. BAUDRATE
    19200
2. SAVE INFO
```

The baud rate can be changed by using the   key.

The setting changes as below:

19200 → 9600 → 4800

When [SET] key is pressed, the cursor will return to the “1.BAUDRATE”. To enter the baud rate setting, select “2.SAVE INFO”, and press the [SET] key. If “2.SAVE INFO” is not pressed, the baud rate will not change.

## 6.6 Data Clear Menu

### To delete stored measurement data

Move the cursor to item “5.DATA CLEAR” of the main menu by using the  $\triangle$   $\nabla$  key, and press the [SET] key. The screen as shown below will be displayed. When there is no data record, a message “There is no record, Please set MENU key” will be displayed.

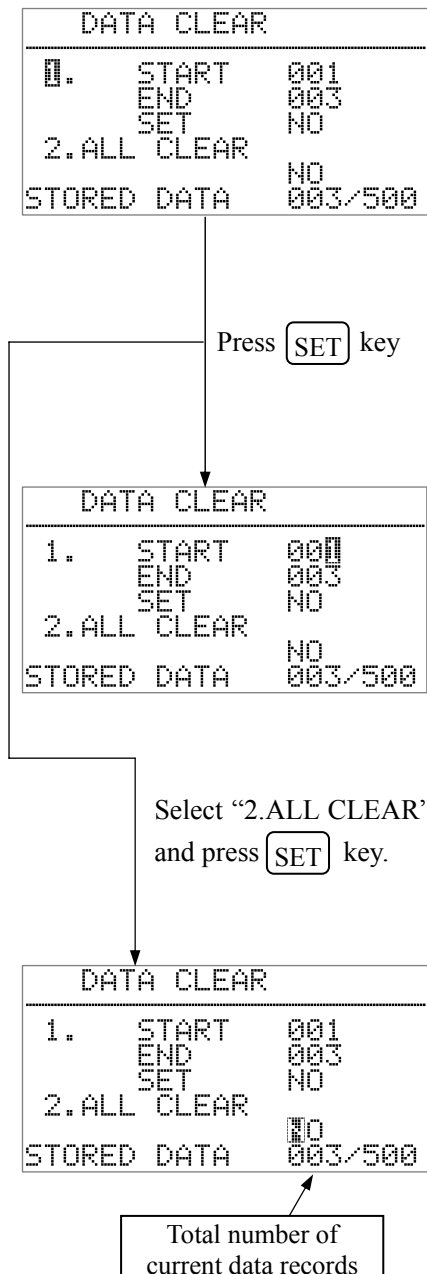

For selecting the data to be deleted:

Select “1” by using the  $\triangle$   $\nabla$  key, and press the [SET] key. The cursor will move to the data number of the START as shown in the middle screen on the left.

Use the [SET] key to move between items, and the  $\triangle$   $\nabla$  key to switch between YES and NO.

**START:** Input the data number of the data you wish to delete, or the first number of the consecutive data numbers you wish to delete.

**END:** Input the last number of the consecutive data numbers you wish to delete, or the same number as inputted for START if the data to be deleted is one.

**SET:**

- To cancel deletion, select NO and press the [SET] key.
- To delete data of the selected data number, select YES and press the [SET] key.

To clear all stored data:

Move the cursor to item “2.ALL CLEAR” and press the [SET] key.

Switch between YES and No by using the  $\triangle$   $\nabla$  key.

- When pressing the [SET] key on NO, the cursor will return to “2”.
- To delete all stored data, select YES and press the [SET] key. All data will be deleted and the message “There is no record, Please set MENU key” will be displayed.

Press the [MENU] key to return to the menu.

## 7. Printing

### 7.1 Connecting the Printer

Connect the 3521 communication port to the printer referring to the operation manual of the printer. Set the communication baud rate to 9600bps. (The factory default setting is 9600.)

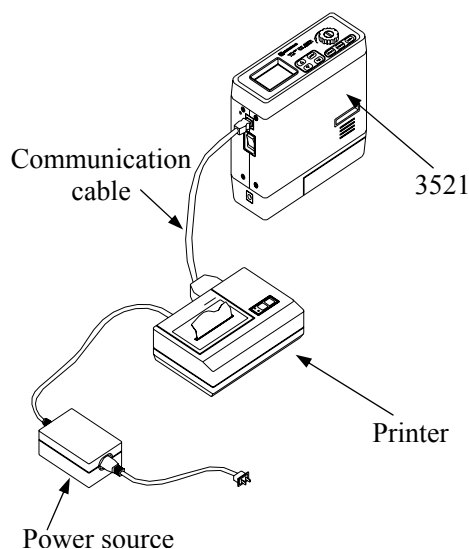

### 7.2 Print Output Menu

#### To print stored data

Data can be printed from this menu. See the following directions for printing.

Move the cursor on the “4. Print Output” of the main menu and press the [SET] key. When there is no data record, a message “There is no record, Please set MENU key” will be displayed.

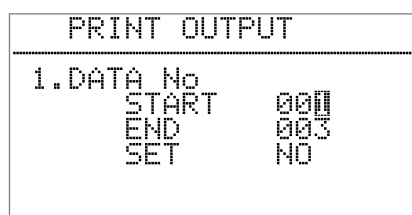

Press **SET** key

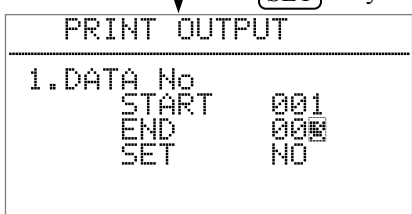

Press **SET** key

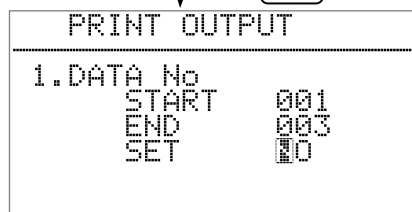

**START:** Select the first number of the data to be printed by using the **▲** **▼** key. Press the [SET] key to proceed.

**END:** Select the last number of the data to be printed by using the **▲** **▼** key. If the data to be printed is only one, input the same data number as inputted for START.

Switch between YES and NO by using the **▲** **▼** key.

- To cancel printing, press the [SET] key on NO, and the cursor will return to the initial position as shown in the first screen on the left. The data number must be inputted again.

- To print selected data, press the [SET] key on YES.

When printing is complete, the cursor will return to the initial position as shown in the first screen on the left.

#### **Caution:**

- 1) Before printing, confirm both the communication setting between the instrument and printer and the power supply to the printer.
- 2) The baud rate of both the instrument and printer must be set to 9600bps.
- 3) During printing the message “PRINT OUTPUT” will be displayed.

## 8. Regular Maintenance and Impactor Nozzle Replacement

---

Regular maintenance is required to ensure the long-term accuracy and performance of the instrument.

In order to maintain the initial accuracy, it is recommended that the sensor and impactor plate are cleaned before and after use. If the instrument is used for a long term, or used in a high concentration environment, periodical cleaning of the needle is recommended.

### 8.1 Impactor Cleaning

The impactor knob can be removed by turning it counter-clockwise. The impactor nozzle can also be removed by turning it counter-clockwise. To clean the impactor knob, wipe off the dust accumulated on the impactor plate by using detergent or alcohol. To clean the impactor nozzle, blow clean air from the inlet to blow off the dust. When water or alcohol is used, be sure to fully dry the parts before re-assembling.

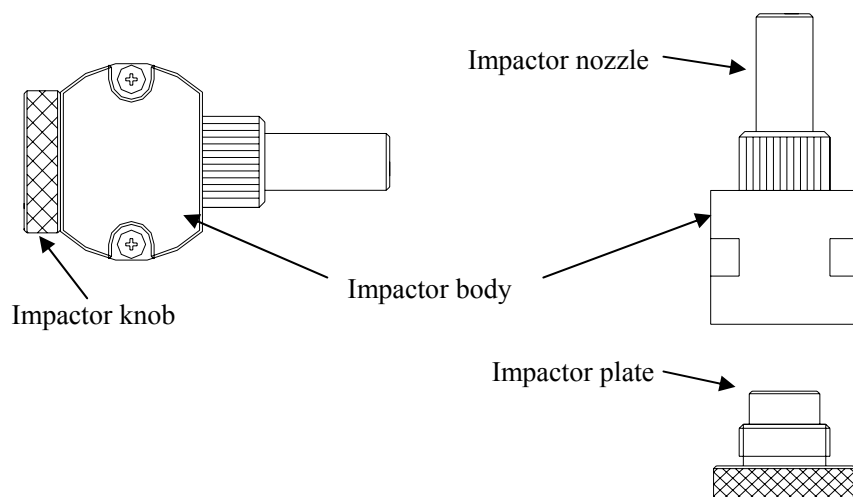

#### Caution:

If a large amount of dust is accumulated on the impactor plate, rescattering may prevent accurate measurement.



## 8.2 Removing and Cleaning the Needle

When the knob is turned left to the “O” (open) mark, the knob will pop up. Pull up the knob slowly to remove the needle. Be careful not to damage the two O rings attached to the needle.

For cleaning the needle you will need an Ultrasonic Cleaner. Prepare a cleaning solution made up of 1/2 dedicated detergent and 1/2 pure water. The cleaning container should hold just enough cleaning solution to cover the lower portion of the needle only. Place the needle in the solution and run the Ultrasonic Cleaner for approx. 15min.

Note that when placing the needle into the detergent, only the lower portion of the needle; up to the O ring, should be immersed in the detergent. Do not dip the upper portion of the needle in the detergent.

Before re-inserting the needle into the instrument, ensure it is completely dried or damage to the instrument may occur.

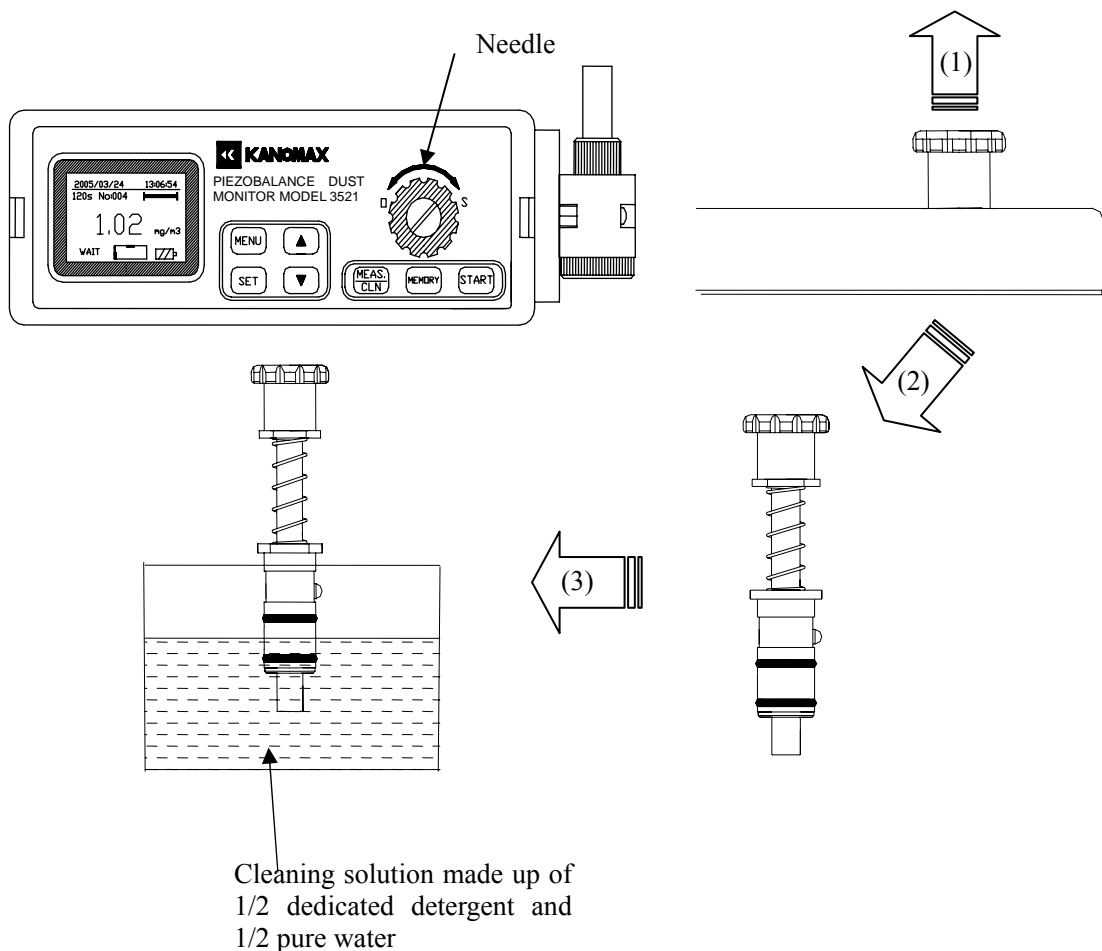

### 8.3 Installing the Needle

To reinstall the needle, look into the inlet from above and align the high-voltage terminal at the side of the needle with the groove inside the inlet, and slowly twist in the needle. When the needle is fully inserted, lock in the needle by turning the knob to the “S” mark until it cannot be turned any further.

Turn on the power of the instrument and press the [MEAS/CLN] key to confirm that the high voltage current is supplied, and the pointer stops at the center of the high voltage indicator frame.

#### Caution:

- The needle should be removed only when necessary. Do not pull out the needle unless required.
- If the screw portion at the center of the knob is extruding from the knob, the needle may not be inserted properly.

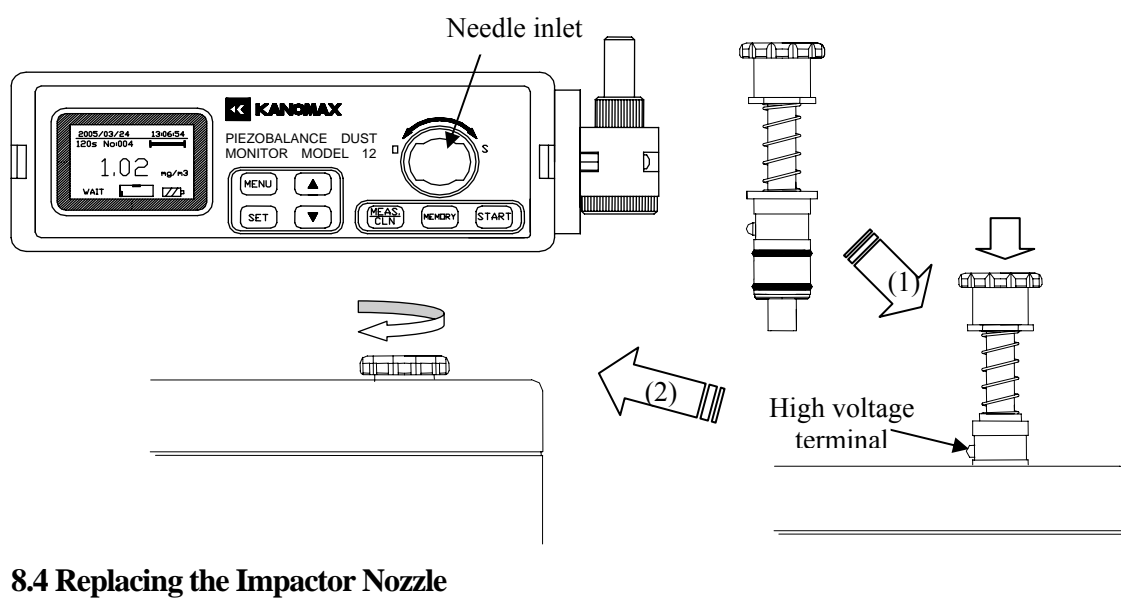

### 8.4 Replacing the Impactor Nozzle

The instrument is equipped with the impactor nozzle (1) before shipping.

To perform a working environment measurement, replace the nozzle (1) to the nozzle (2).

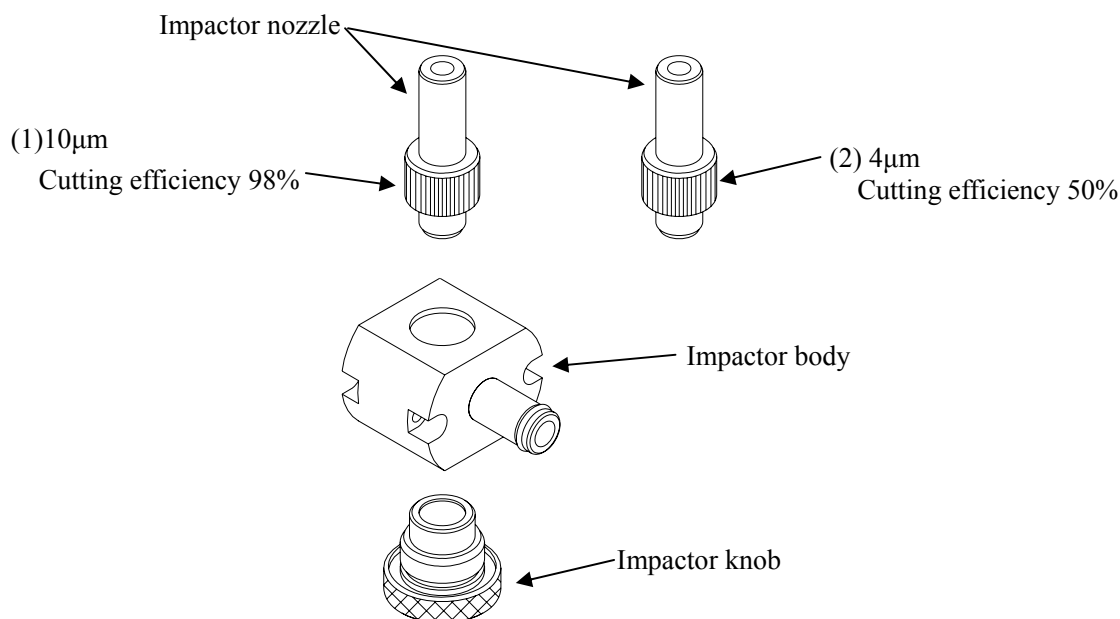

## 9. Main Specifications

|                             |   |
|-----------------------------|---|
| Product Name                | Piezobalance Dust Monitor   |
| Model                       | 3521  |
| Measuring Object            | Mass concentration of suspended particulate matter in indoor or outdoor air.  |
| Operating Temperature Range | -10°C to 40°C   |
| Storage Temperature Range   | -30°C to 60°C   |
| Measuring Range             | 0.01 to 5mg/m <sup>3</sup>  |
| Measuring Particle Size     | Φ10μm (below 98%) or Φ4μm (below 50%)<br>(depends on which impactor nozzle is used)   |
| Particle Sizing Method      | Impactor (Inertial Impaction)   |
| Measuring Time              | 24s, 120s, 1-60min (Preset by the menu)   |
| Measuring Accuracy          | ±10% of the calibration particles   |
| Resolution                  | 0.01mg/m <sup>3</sup>   |
| Suction Flow                | 1 L/min   |
| Cleaning System             | Manual cleaning of the sensor   |
| Communication Protocol      | Standard RS232C   |
| Communication Baud Rate     | 4800bps, 9600bps, 19200bps (Preset by the menu)   |
| Maximum Data Records        | 500 records   |
| Weight                      | Approx. 1.8kg   |
| Dimensions                  | 65×180×150 mm (W×L×H)   |
| Power Source                | 1) AC/DC adapter (input: AC100-240V)<br>2) Built-in Ni-MH battery (9.6V-1.5AH),<br>Continuous operation: approx. 4.5h with 5-8h charging time   |
| Standard Accessories        | 1) Cleaning Device ..... 3<br>2) Detergent/Purified Water ..... 30cc bottle each<br>3) Strap ..... 1<br>4) AC Adapter ..... 1<br>5) Φ4μm impactor nozzle ..... 1<br>6) Communication Cable ..... 1<br>7) Communication Software CD-ROM ..... 1<br>8) Operation Manual ..... 1<br>9) Carrying Case ..... 1 |
| Options                     | 10) Printer ..... 1<br>11) Printer AC/DC Adapter ..... 1<br>12) Printer Cable ..... 1   |

\* Certain test functions required in China are not included

## 10. Troubleshooting

Please review the following troubleshooting tips before requesting a repair.

| Symptom  | Possible Cause   | Solution   |
|--|--|--|
| Display does not appear when turning on the power. (No display on the Screen.) | Battery completely discharged.   | Turn OFF the power and charge the battery.   |
|  | Contact failure of the battery pack.   | Remove and reinstall the battery pack.   |
| Blurred screen. (Hard to see LCD.)   | The contrast of the display is not adjusted properly.  | Adjust the contrast level with a screw driver.   |
| High voltage cannot be supplied  | Needle is not inserted properly.   | Remove and reinstall the needle.   |
|  | “WAIT” keeps blinking.   | Remove any excess moisture on the cleaning device and perform cleaning again.  |
|  | “CLEANING” keeps blinking  | Clean the sensor.  |
| Concentration reading is “—.—.—.”  | [START] key is pressed during a measurement.   | Remeasurement is required.   |
|  | [MEAS/CLN] key is pressed during a measurement.  | Remeasurement is required after turning on the high voltage supply.  |
| Battery indicator is blinking.   | Remaining battery power is low.  | Charge the battery immediately.  |
|  | Battery contacts not seated properly.  | Remove and reinstall the battery pack.   |
| The measurable range does not recover even after cleaning.                     | Excess moisture on the sensor.   | Remove any excess moisture on the cleaning device and perform cleaning again.  |
|  | Oily residue on the sensor.  | Apply 1-2 drops of detergent on the smaller sponge of the cleaning device, insert the cleaning device up to the scale line, wait 4-5 minutes, and then pull out the cleaning device. |
|  | The tip of the needle has fused due to high voltage arcing causing metal residue to attach to the sensor area (the crystal). | Pull out the needle and check the discoloration of the sensor area (the crystal). When discoloration is observed, the instrument must be sent out for repair.                        |
| Communication failure.   | Incorrect baud rate.   | Confirm the baud rate.   |

## 11. Warranty and After-sales Service

---

### Warranty

- A warranty card is not included in this product.
- The instrument (excluding consumables such as batteries) is warranted against defects in materials and workmanship under normal use for a period of one year from the date of original purchase.

### After-sales Service

- When you have a problem with your unit, please check out the “Troubleshooting” section first.
- If you cannot resolve the problem, please contact your local distributor, or call our service center (See last page for contact information).
- During the warranty period, we will repair at no charge a product that proves to be defective due to material or workmanship under normal use. The limited warranty covers all defects encountered in normal use of the product, and does not apply in cases such as; loss or damage to the product due to abuse, mishandling, or alternation by the customer, or natural disaster. All return shipping charges are the responsibility of the customer.
- Repair after warranty expiration:  
Upon request, we will evaluate and provide an estimate for repair of the instrument at the customer’s expense.
- Replacement parts are available for a minimum period of five (5) years after termination of production. This storage period of replacement parts is considered as the period during which we can provide repair service. For further information, please contact our service center.

When making an inquiry, please provide the following information.

- \* Product Name: Piezobalance Dust Monitor
- \* Model Number: 3521
- \* Serial Number: -----
- \* Date of Purchase: -----
- \* Description of Symptom in Detail:

## 12. Contact Information

---



### JAPAN & ASIA

#### **KANOMAX JAPAN, INC.**

2-1 Shimizu Suita City, Osaka 565-0805, Japan

**TEL:** 81-6-6877-0183 **FAX:** 81-6-6879-5570

**URL:** <http://www.kanomax.co.jp/>

**E-Mail:** [sales@kanomax.co.jp](mailto:sales@kanomax.co.jp)

### USA & EUROPE

#### **KANOMAX USA, INC.**

PO Box 372, 219 Route 206, Andover, NJ 07821 U.S.A.

**TEL:** (800)-247-8887 / (973)-786-6386 **FAX:** (973)-786-7586

**URL:** <http://www.kanomax-usa.com/>

**E-Mail:** [info@kanomax-usa.com](mailto:info@kanomax-usa.com)

### CHINA

#### **Shenyang Kano Scientific Instrument Co., Ltd**

No. 12, 4 Jia Wencui Road Heping District

Shenyang City PRC

**TEL:** 86-24-23845309 **FAX:** 86-24-23898417

**URL:** <http://www.kanomax.com.cn/>

**E-mail:** [sales@kanomax.com.cn](mailto:sales@kanomax.com.cn)